

VAHLE

Battery Charging Systems

SYSTEMS IN MOTION



Battery Charging Systems

Content	Seite
General	3
Models	4
General installation instructions	7

The operation of Automatic Guided Vehicles (AGVs) requires high utilization of these vehicles in order to achieve an optimum of profitability. Often, recharge of the batteries which are required for the drive of the AGVs, presents a problem.

The development of powerful batteries, which allow for quick recharge within seconds, enables the integration of charging contacts into the production cycle without removing the AGVs from the production process.

Battery charging stations may be installed anywhere within the system where the production process allows the AGV to stop (staging areas, turn arounds, loading stops etc.). Attention should be paid to attain best possible integration into a given layout.

VAHLE has developed special battery charging contacts which fully meet any requirement.

A battery charging contact consists of a base plate, which is installed on the floor or laterally at a bracket adjacent of the AGV runway, and a current collector which is installed on the vehicle.

A battery charger supplies current to the base plate. Once the AGV is in charging position and the collector has made contact with the base plate, the AGV computer turns on the current.

The base plate has chamfered entry/exit ramps to facilitate smooth drive-on/drive-off of the spring loaded collector. Bristle brushes installed on the collector remove debris from the base plate.

VAHLE battery operating charging contacts are designed for an voltage of 12 - 80 V. Nominal voltages > 25 VAC or 60 VDC require a protection gainst accidental touch.

AGVs serve as transportation vehicles and mobile assembly platforms. They connect assembly areas with assembly lines, service AS/AR installations etc. The great variety of possible applications often requires custom designed AGVs with very specific demands for battery charging contacts.

A selection of our wide range of battery charging contacts is shown on the following pages.

AGV: 12 units
Charging stations: 4 units
Batteries: 12 units
3-Shift-Operation

- 1 = Loading stop
- 2 = Assembly Place
- 3 = Hand-over area
- 4 = AGV staging area
- 5 = Charging stations
- 6 = Buffer store and floor mounted charging contacts

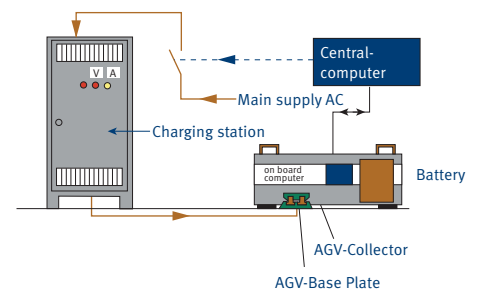
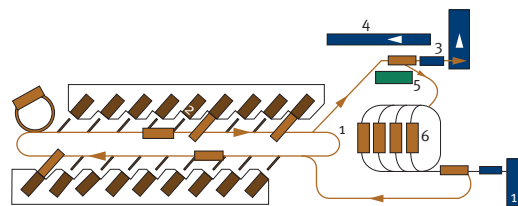

Schematic layout of power supply for Automatic Guided Vehicles (AGVs)

Models

AGV-Collector

2-phase, charging current 200 A
Insulated collector for vehicle installation, with two contact brushes and a bristle cleaning brush.

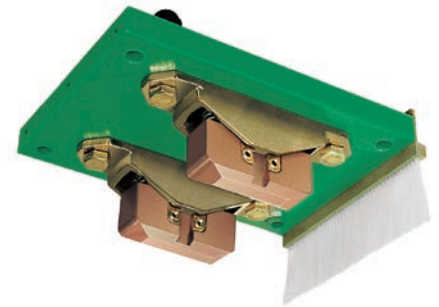
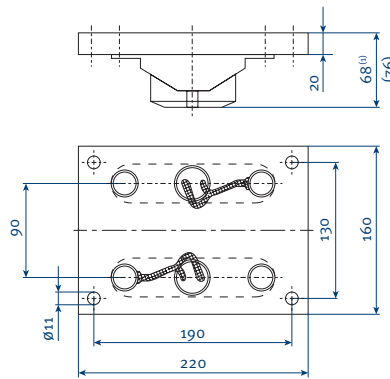

Type	Weight kg	Order-No.
SA-BLS200-2-01	2,600	590 000

AGV-Base Plate

2-phase, charging current 200 A

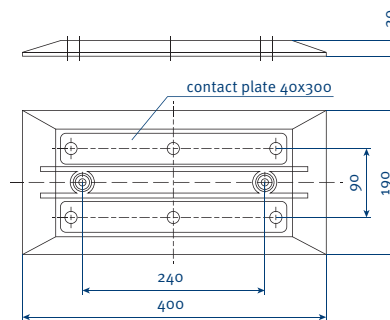

Type	Weight kg	Order-No.
BLK 200-2-01	2,200	590 001

AGV-Collector

2-phase, charging current 200 A
Insulated collector for vehicle installation, with two contact brushes, surrounding bristle cleaning brushes and two-directional drive-on capability.

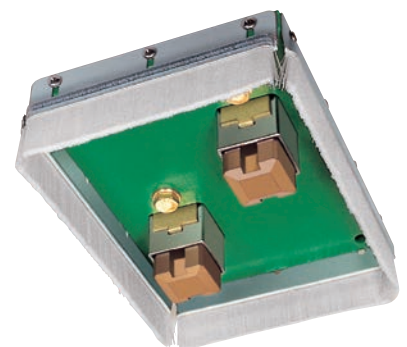
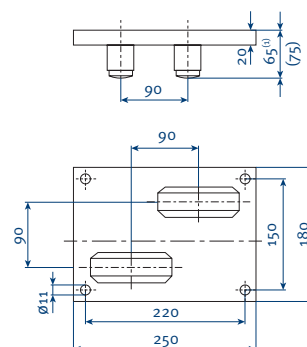

Type	Weight kg	Order-No.
SA-BLS200-2QU-01	3,025	590 013

(a) Height at contact position

Models

AGV-Collector

2-phase, charging current 200 A
Insulated collector for vehicle installation, with two contact brushes each for charging, two pilot contacts and a bristle cleaning brush.

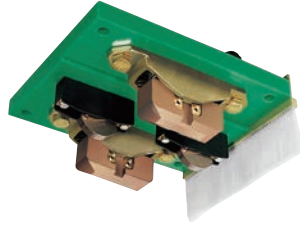
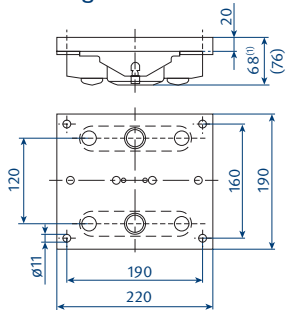

Type	Weight kg	Order-No.
SA-BLS 200-2B/20-2-01	3,000	590 198

AGV-Base Plate

2-phase, charging current 200 A
Insulated Floor contact plate with two copper contact plates for charging and two pilot copper contact plates.

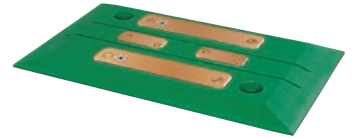
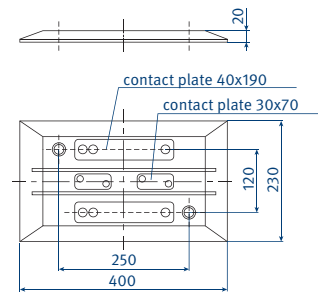

Type	Weight kg	Order-No.
BLK200-2/25-2-01	2,700	590 062

AGV-Collector

2-phase, charging current 20 A

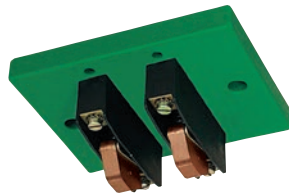
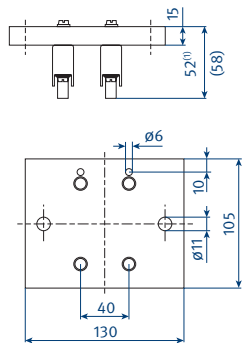

Type	Weight kg	Order-No.
SA-BLS20-20-01	0,310	590 207

AGV-Base Plate

2-phase, charging current 25 A

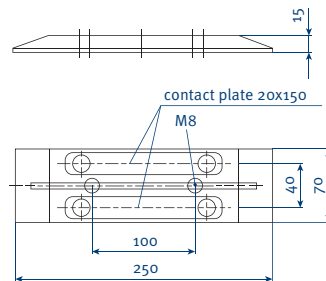

Type	Weight kg	Order-No.
BLK25-2-01	0,590	590 042

(i) Height at contact position

Models

AGV-Collector

single-phase, charging current 200 A
Insulated collector for vehicle installation, with one contact brush and one bristle cleaning brush (to be used in pairs).

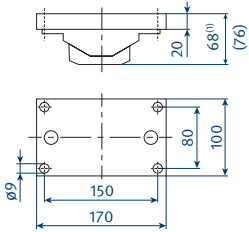

Type	Weight kg	Order-No.
SA-BLS200-1-04	1,362	590 035

AGV-Base Plate

single-phase, charging current 200 A
Insulated Floor contact plate, complete with single copper contact.

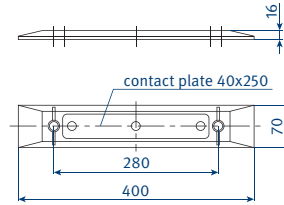

Type	Weight kg	Order-No.
BLK 200-1-01 W	0,890	590 036

AGV-Collector

single-phase, charging current 600 A
Insulated collector for vehicle installation, with three contact brushes and one bristle cleaning brush (to be used in pairs).

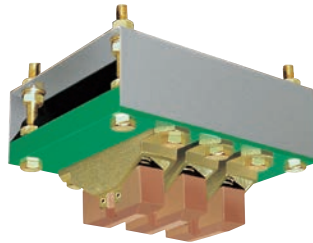
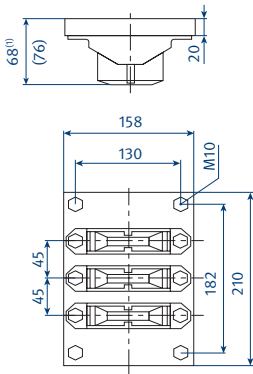

Type	Weight kg	Order-No.
SA-BLS600-1A0-01	4,100	590 043

AGV-Base Plate

single-phase, charging current 600 A
Insulated Floor contact plate, complete with single copper contact.

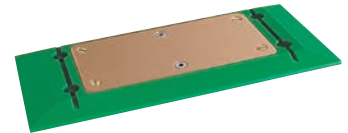
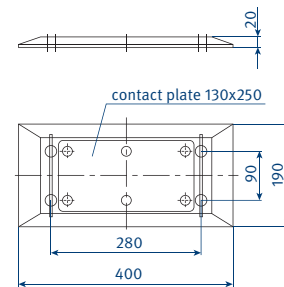

Type	Weight kg	Order-No.
BLK600-1-01	3,000	590 044

(a) Height at contact position

Models

AGV-Collector

2-phase, charging current 200 A
Insulated collector for vehicle installation,
with two contact brushes and cover pusher.

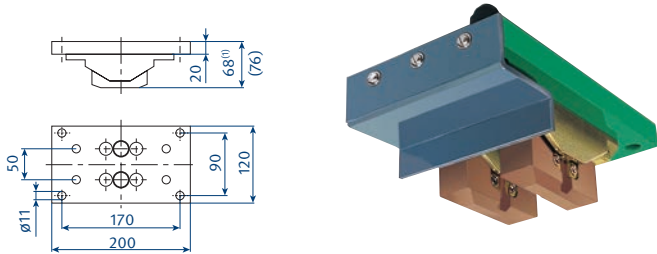

Type	Weight kg	Order-No.
SA-BLS200-2E-01	2,260	590 065

AGV-Base Plate

2-phase, charging current 200 A
Insulated Floor contact plate with two copper contacts,
spring loaded cover and 2 x 2 m connecting cables.

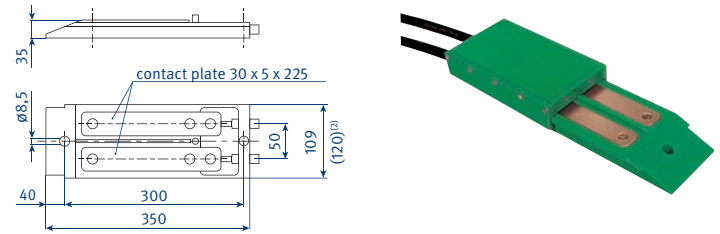

Type	Weight kg	Order-No.
BLK200-2EA-01	3,926	590 064

General installation instructions

Install AGV-collectors on vehicle with bristle cleaning brushes in direction of travel.

Install AGV-Base Plate on top of the floor.

The *marked height 68 (65, 45) of AGV-Collectors type BLS is the dimension at contact position. Allowable tolerance: + 2 mm. In order to guarantee sufficient contact pressure the max. wear reduction of the contact brushes is limited to 5 mm whereby the unevenness of the floor must be considered.

Between base plate and cutout at concrete floor a dust- and waterproof sealing has to be installed.

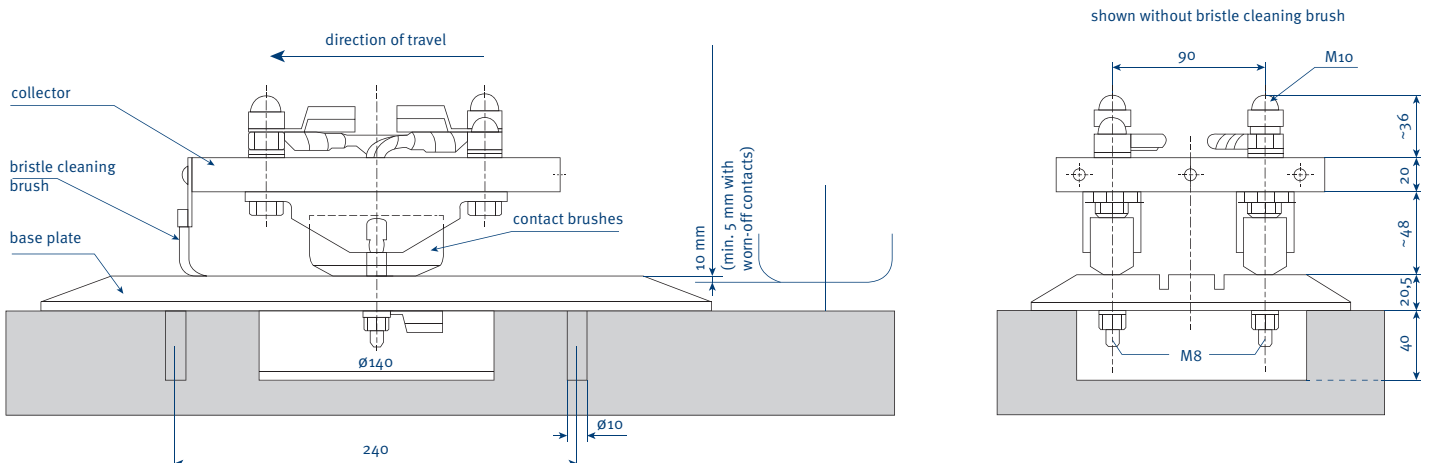

(1) Height at contact position
(2) Dimensions incl. coverage

Scope of delivery and services

Catalog no.

1 Open conductor systems	
Open conductor systems	1a
2 Insulated conductor systems	
U10	2a
FABA 100	2b
U15, U25, U35	2c
U20, U30, U40	2d
3 Compact conductor systems	
VKS 10	3a
VKS - VKL	3b
VMT	3c
4 Enclosed conductor systems	
KBSL - KSL	4a
KBH	4b
MKH	4c
LSV - LSVG	4d
5 Contactless power supply	
Contactless power supply (CPS®)	5a
6 Data transmission	
VAHLE Powercom®	6a
Slotted Microwave Guide (SMG)	6b
7 Positioning systems	
VAHLE APOS®	7a
VAHLE APOS® Optic	7b
8 Festoon systems and cables	
Festoon systems for □-tracks	8a
Festoon systems for flatform cables on I-tracks	8b
Festoon systems for round cables on I-tracks	8c
Festoon systems for ◇-tracks	8d
Cables	8e
9 Reels	
Spring-operated cable reels	9a
Motor-powered cable reels	9b
10 Other	
Battery charging systems	10a
Heavy enclosed conductor systems	10b
Tender	10c
Contact wire	10d
11 Automotive Handling	
Control systems	11a
BOK	11b
Assemblies / Commissioning	
Spare parts / Maintenance service	



DQS certified in accordance with DIN EN ISO 9001:2008
OHSAS 18001 (Reg.No. 003140 QM OH)